

MONTAGEANLEITUNG DRÜCKERGARNITUR SCHRAUBTECHNIK SMART2LOCK 2.0
MOUNTING INSTRUCTIONS HANDLE SET SCREW-ON TECHNIQUE SMART2LOCK 2.0

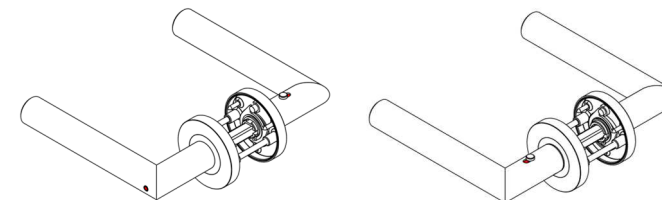

Ausgelegt für Türstärkenbereich /
designed for door thickness range

38-45mm

für größere Türstärken werden
Erweiterungssets benötigt / extension sets
are required for larger door thicknesses

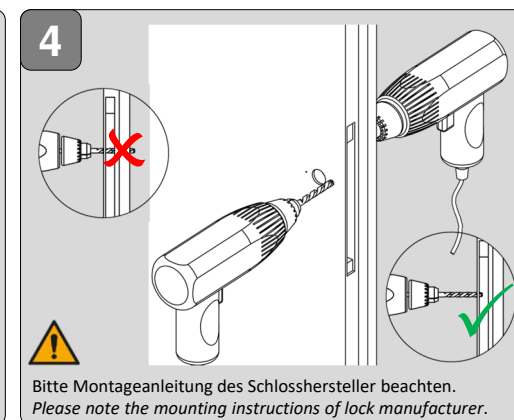
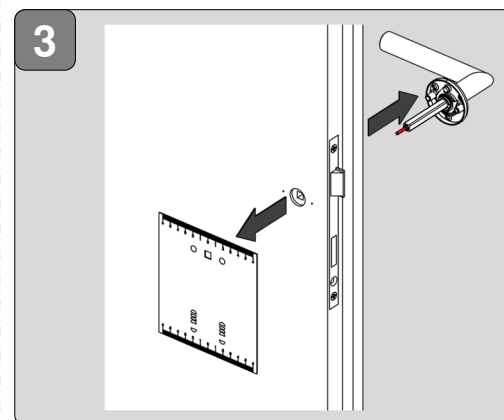
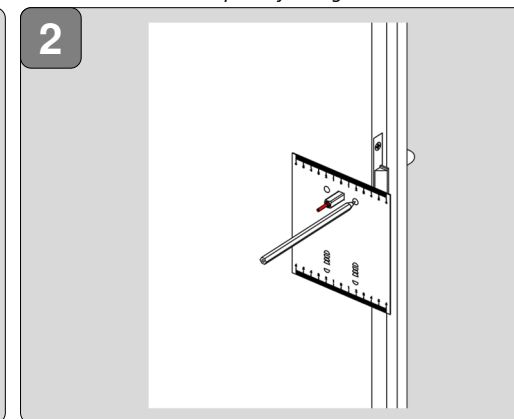
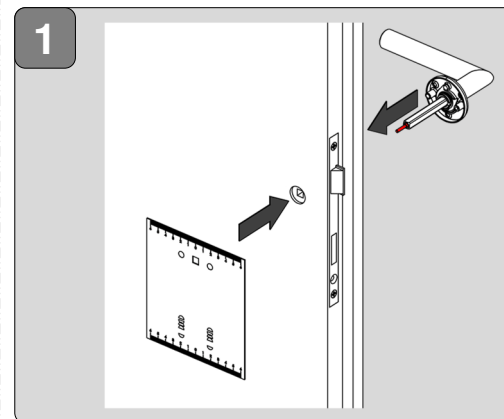

5  Stift muss über den Griff herausstehen / Pin must protrude over the handle

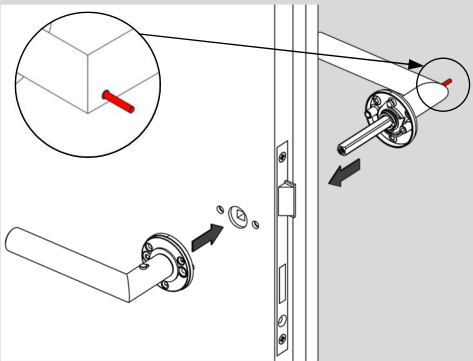

6

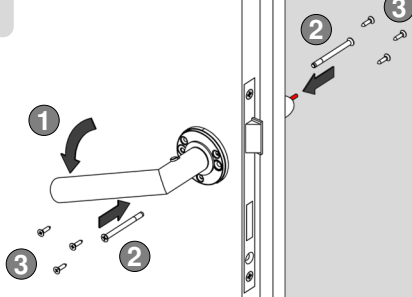

7

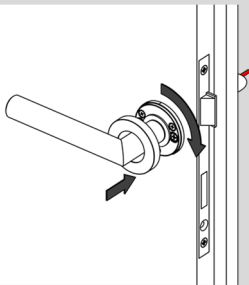

8 Griffunterseite / handle bottom

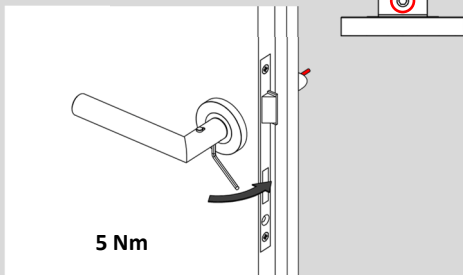

 Bei erneuter Montage neue Madenschraube oder Schraubensicherung verwenden / Use a new grub screw or screw lock when reinstalling

9

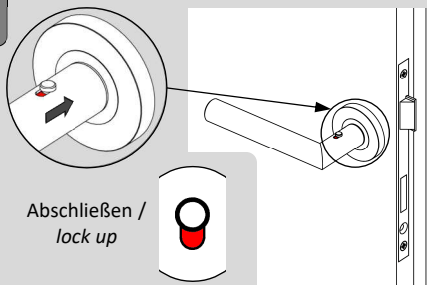

10

10

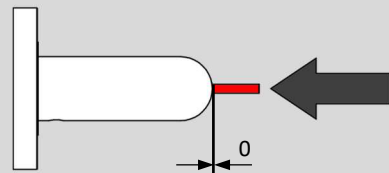

Pin zurückschieben, bis er mit dem Griff bündig ist / Push the pin back until it is flush with the handle

Griffunterseite / handle bottom

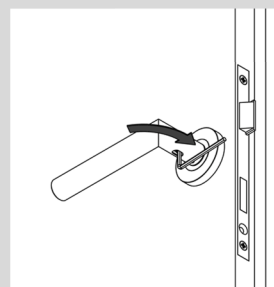

 Madenschraube nur Handfest anziehen / Tighten grub screw only hand tight

Notentriegelung / emergency release

 **Notentriegelung nach erfolgter Montage prüfen / check emergency release after installation**

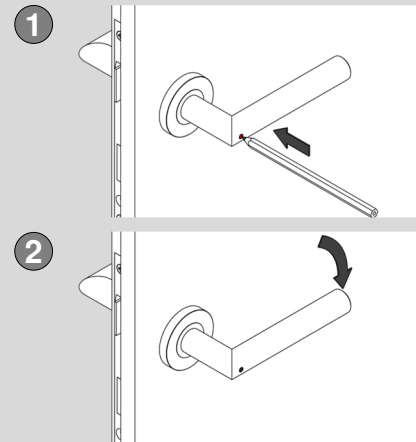

Geeignet sind Gegenstände mit einem Durchmesser von $\leq 3\text{mm}$ und einer Länge von mind. 4mm / Objects with a diameter of $\leq 3\text{mm}$ and a length of at least 5mm are suitable

- z.B / e.g.
- Bleistift / pencil
 - Kugelschreiber / ballpoint pen
 - Zahnstocher / toothpick
 - Büroklammer / paperclip

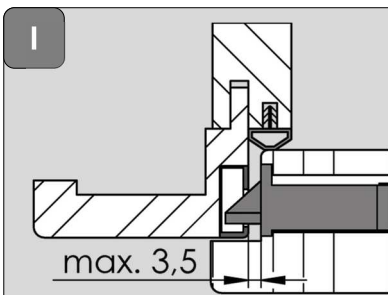

Um eine einwandfreie Funktion der SMART2LOCK Garnituren zu gewähren, darf der Abstand zwischen Schließblech und Schloßstulp max. 3,5mm betragen. Ggf. muss das Türblatt über ein Einstellen der Bänder angepasst werden.

In order to ensure proper functioning of the SMART2LOCK fittings, the distance between the strike plate and the lock faceplate must not exceed 3.5 mm. If necessary, the door leaf must be adjusted by adjusting the hinges.